

DOWNLIGHTS

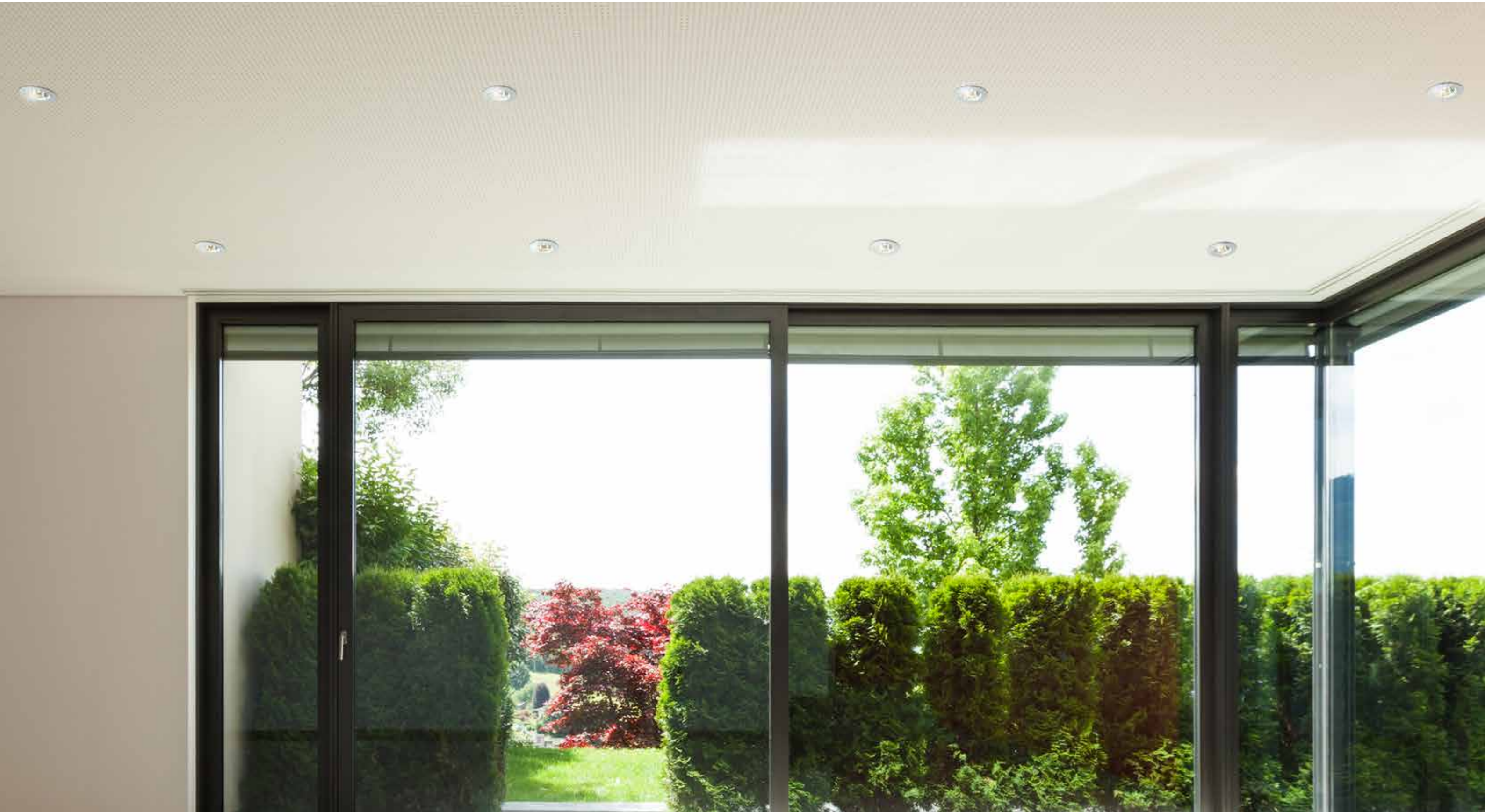

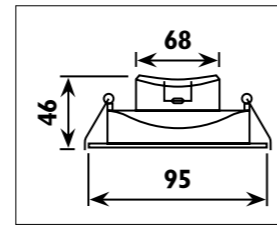

LDL0002W



LDL0002W



LDL0003W • LDL0004W

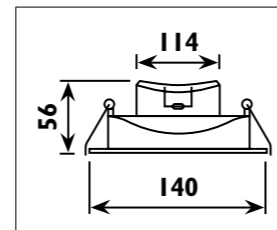

LDL0003W • LDL0004W



LDL0008W

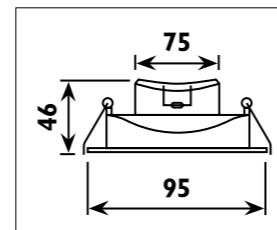

LDL0008W

Plastic body									
Code	Class	IP	QC	Lamp/s		Lumen	Cutout	Colour/s	
				LED (Factory fitted)			(mm)	White	
				3000K	4000K				
LDL0002W	II	20	21	6w		470	Ø 75	.	
LDL0003W	II	20	21		12w	920	Ø 120	.	
LDL0004W	II	20	21	12w		920	Ø 120	.	
LDL0008W	II	20	21	6w		470	Ø 75	.	



LBT001 • LBT002 • LBT003

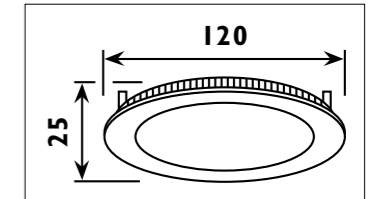

LBT001

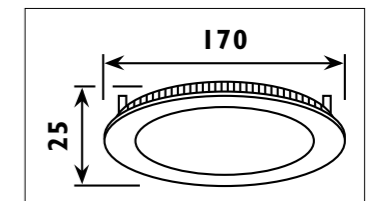

LBT002

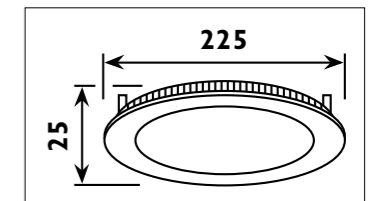

LBT003

Aluminium body									
Code	Class	IP	QC	Lamp/s		Lighting effects	Lumen	Cutout	Colour/s
				LED	Dimmable	RGB		(mm)	White
				(Factory fitted)					
				2500K-6000K					
LBT001	II	20	22	6w	.	.	300	Ø 108	.
LBT002	II	20	22	12w	.	.	600	Ø 155	.
LBT003	II	20	22	18w	.	.	900	Ø 210	.



LDL062 • LDL063

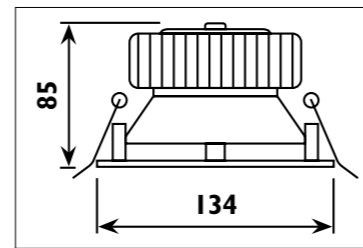

LDL062 • LDL063



LDL0006SC • LDL0007SC

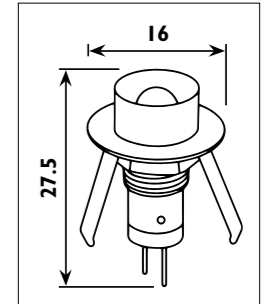

LDL0006SC • LDL0007SC
LDL0006BL • LDL0007BL











LDL0006BL • LDL0007BL



12 per kit



LDL062 • LDL063 Die-cast aluminium body								
Code	Class	IP	QC	Lamp/s  LED (Factory fitted) 4000K	Lumen 	Cutout  (mm)	Colour/s  White	Backup 3 hours
LDL062	I	20	21	15w	1840	Ø 125	•	
LDL063	I	20	21	15w	1840	Ø 125	•	•

Die-cast aluminium body							
Code	Class	Lamp/s  LED (Factory fitted) 5000K 3000K	Lumen 	Cutout  (mm)	Colour/s  Satin chrome  Black		
LDL0006SC	II	12 x 0.2w	72	12	•	•	
LDL0006BL	II	12 x 0.2w	72	12	•	•	
LDL0007SC	II	12 x 0.2w	72	12	•	•	
LDL0007BL	II	12 x 0.2w	72	12	•	•	

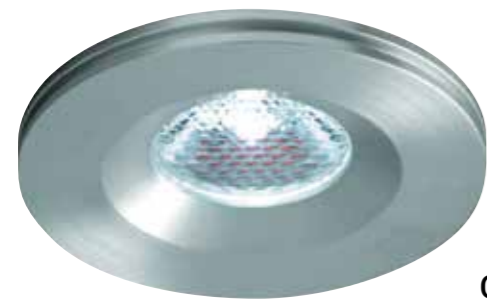

CL20

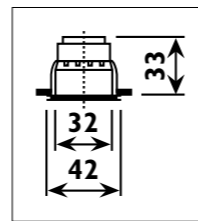

CL20



LN348-3

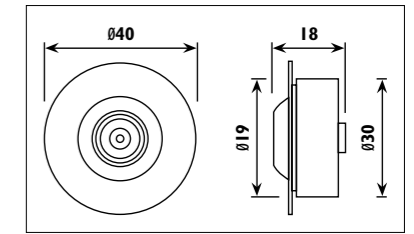

LN348-3



LN349-3

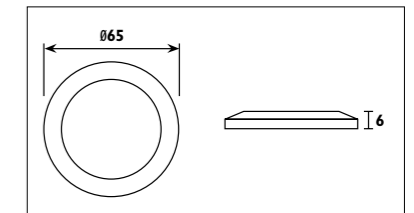

LN349-3



LN351-3

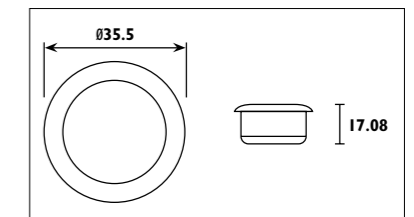

LN351-3

CNC aluminium body								
Code	Class	IP	QC	Lamp/s	Cutout	Feature/s	Colour/s	
				LED (Factory fitted) 4000K Driver required (Current 700mA) L1	(mm)	Beam angle	Aluminium body	
CL20	III	20	32	3w	Ø 38	15°	•	

ABS/Aluminium body (LN351/3)							
Code	Class	Lamp/s	Feature/s		Lumen	Colour/s	
		LED (Factory fitted) 4000K	Beam angle	Tilt		Matt white	Silver
LN348/3	II	3x1.5w		30°/60°	240	•	•
LN349/3	II	3x1.5w	120°		300	•	
LN351/3	II	3x1.5w	38°		270	•	



LN352-3

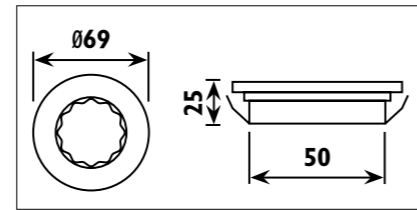





LN352-3

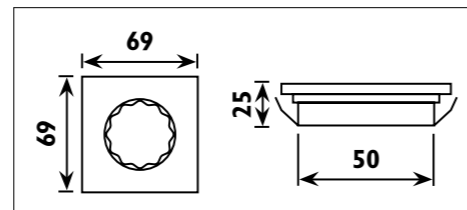

LN353-3



LN353-3

Zinc alloy and PC						
Code	Class	Lamp/s  LED (Factory fitted) 4000K	Cutout  (mm)	Feature/s  Beam angle	Lumen 	Colour/s  Satin silver
LN352-3	II	3x1.5w	Ø 55	90°	360-390	•
LN353-3	II	3x1.5w	Ø 55	90°	360-390	•



LDL001



LDL001/A



LDL002



LDL025

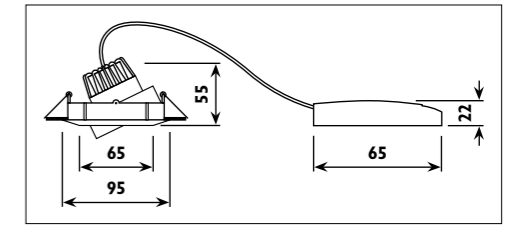

LDL001

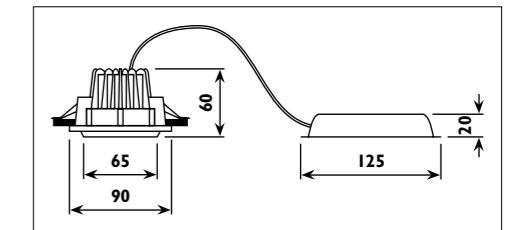



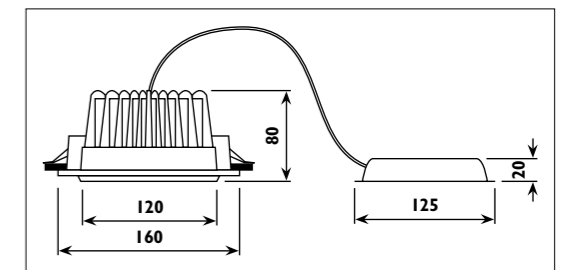

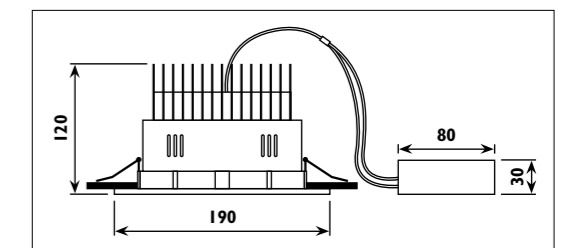

LDL001/A



LDL002



LDL025

Die-cast aluminium body										
Code	Class	IP	QC	Lamp/s		Cutout  (mm)	Feature/s  Tilt	Lumen 	Colour/s	
				 LED (Factory fitted) 3000K	 Dimmable 3500K				 Satin silver	 White
LDL001	II	20	22		6.5w	•	Ø 80	352.40	•	•
LDL001/A	III	20	21	6.5w	6.5w	•	Ø 82	298.1		•
LDL002	II	20	22		15w	•	Ø 150	750.80	•	•
LDL025	II	20	22		25w	•	Ø 175	1473.7	•	•



CL61

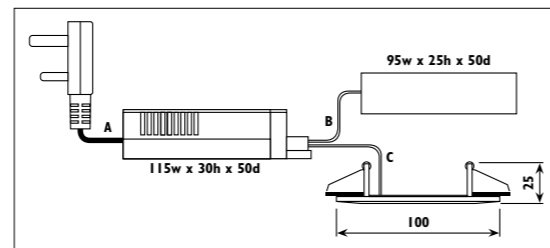

CL61





Lengths: A = 1080mm, B = 220mm, C = 800mm

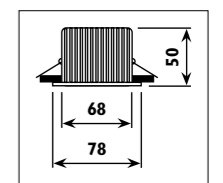





LDL015



LDL015

Polycarbonate body									
Code	Class	IP	QC	Lamp/s  LED (Factory fitted) 6500K	Cutout  (mm)	Feature/s	Battery  Included	Lumen 	Colour/s  White body Cool white LED
CL61	II	20	21	1 x 3w	Ø 90	3 hour emergency operation LED charge display Deep discharge display Test switch with self-test function Complete with cable and plug Easy installation Non-maintained Intelligent automatic recharge function Constant current mode	Ni-Cd 4.8v 2.5Ah	230Lm	.

Die-cast aluminium body							
Code	Class	IP	QC	Lamp/s  LED (Factory fitted) 4000K	Cutout  (mm)	Lumen 	Colour/s  White
LDL015	II	20	22	10w	Ø 68	576	.



LDL007

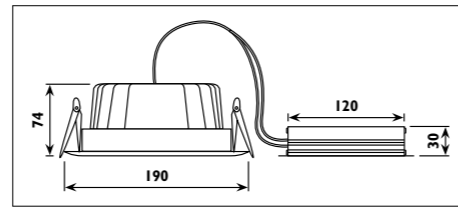

LDL007



LDL017

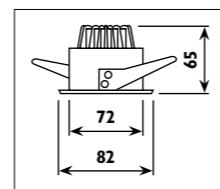

LDL017

Die-cast aluminium body								
Code	Class	IP	QC	Lamp/s LED (Factory fitted) 3500K 6400K	Cutout (mm)	Lumen	Colour/s White	
LDL007	I	20	21	36w	Ø 173	3961.1	.	
LDL017	II	44	22	6.5w	Ø 72	388	.	



LDL030

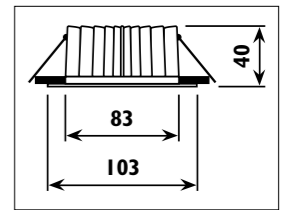

LDL030



LDL031

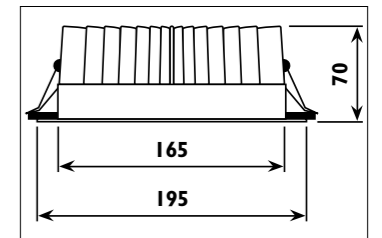

LDL031



LDL032

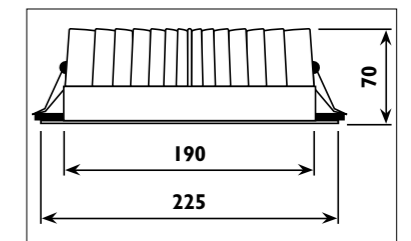

LDL032

Die- cast aluminium body with acrylic lens										
Code	Class	IP	QC	Lamp/s		Dimmable	Cutout (mm)	Lumen		Colour/s White
				LED (Factory fitted) 3000K	6000K			3000K	4000k	
LDL030	II	44	22	8w	8w	.	Ø 92	680Lm	700Lm	.
LDL031	II	44	22	22w	22w	.	Ø 170	1900Lm	2000Lm	.
LDL032	II	44	22	35w	35w	.	Ø 195	2900Lm	3000Lm	.



LDL065-1 • LDL065

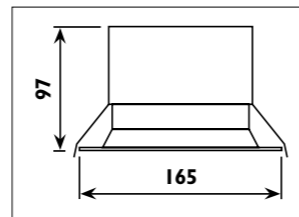

LDL065-1 • LDL065



LDL059
LDL059A • LDL060A

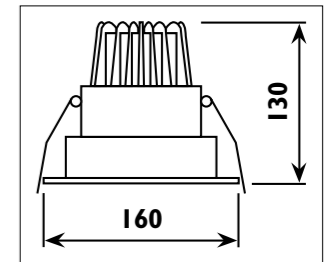





LDL059
LDL059A • LDL060A

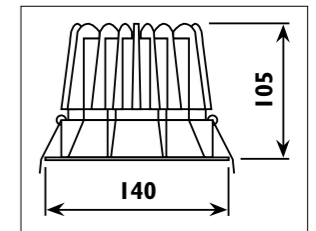







LDL065R



LDL065R

Metal body									
Code	Class	IP	QC	Lamp/s  (Factory fitted)		Cutout  (mm)	Lumen 	Colour/s  Black body white frame	
				3000K	4000K				
LDL065-1	II	20	21	26w		150x150	2700		•
LDL065	II	20	21		26w	150x150	2700		•

Die-cast aluminium body											
Code	Class	IP	QC	Lamp/s  (Factory fitted)		Cutout  (mm)	Feature/s  Beam angle  Tilt		Lumen 	Colour/s  Black  White	
				2500K	3000K						
LDL059	II	20	22	35w		Ø 152	24°	40°	320		•
LDL059/A	II	20	22	35w		Ø 152	24°	40°	320		•
LDL060/A	II	20	22		35w	Ø 152	24°	40°	550		•
LDL065R	II	44	21		18w	Ø 125					•



LDL026

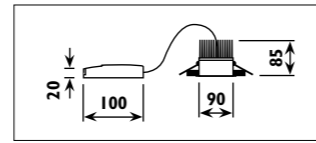

LDL026



LDL028

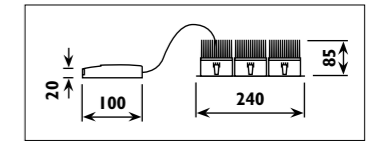

LDL028



LDL027

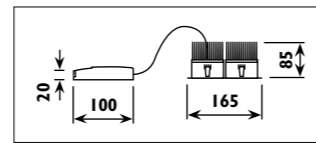





LDL027

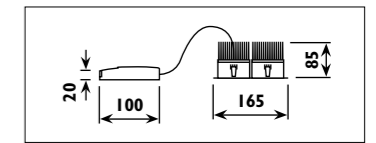





LDL029



LDL029

Die-cast aluminium body							
Code	Class	IP	QC	Lamp/s  LED (Factory fitted) 3500K	Cutout  (mm)	Lumen 	Colour/s  White
LDL026	II	20	22	1 x 10w	Ø 85 x 70	609	•
LDL027	II	20	22	2 x 10w	Ø 145 x 85	1654	•

Die-cast aluminium body							
Code	Class	IP	QC	Lamp/s  LED (Factory fitted) 3500K	Cutout  (mm)	Lumen 	Colour/s  White
LDL028	II	20	22	3 x 10w	Ø 225 x 85	2491	•
LDL029	II	20	22	4 x 10w	Ø 155 x 150	3245	•



LDL056/2

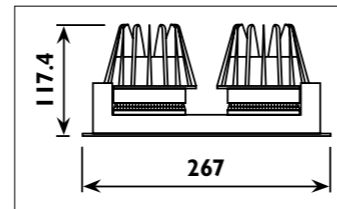

LDL056/2



PRT0029

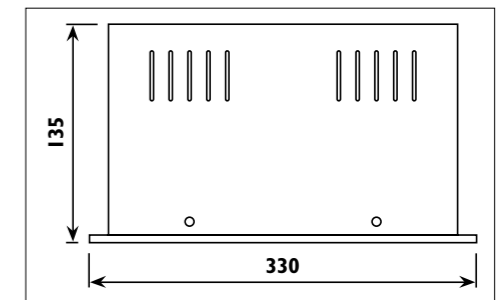

PRT0029



LDL057/3

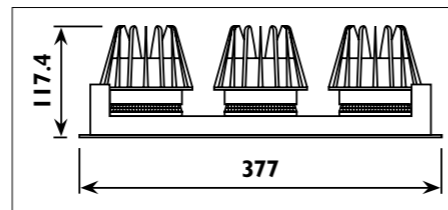

LDL057/3



PRT0030

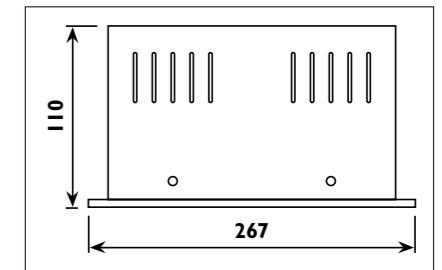

PRT0030

Aluminium body								
Code	Class	IP	QC	Lamp/s LED (Factory fitted) 4000K Dimmable	Lumen 	Colour/s Satin silver/black White		
LDL056/2	II	20	21	2 x 25.5w	2900	•		
LDL056/2	II	20	21	2 x 25.5w	2900	•	•	
LDL057/3	II	20	21	3 x 25.5w	3100	•		

Die-cast aluminium and iron							
Code	Class	IP	QC	Lamp/s LED (Factory fitted) 4000K	Cutout (mm) 	Lumen 	Colour/s Black body/white frame
PRT0029	II	20	24	2 x 30w	320 x 160	4900	•
PRT0030	II	20	24	2 x 25w	256 x 120	3400	•



LDL066 • LDL069

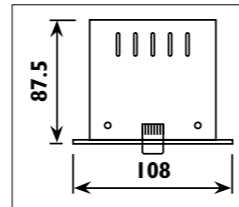

LDL066 • LDL069



LDL070

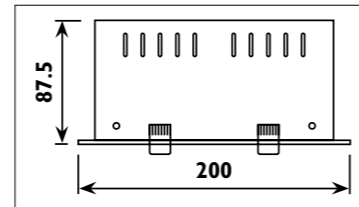





LDL070

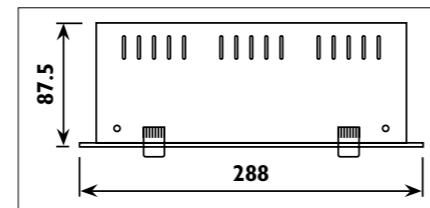

LDL068 • LDL071



LDL068 • LDL071

Metal body							
Code	Class	IP	QC	Lamp/s  LED (Factory fitted) 4000K	Cutout  (mm)	Lumen 	Colour/s  Black body/ white frame
LDL066	II	20	21	9w	97 x 97	720	•
LDL069	II	20	21	9w	97 x 97	720	•
LDL068	II	20	21	3 x 9w	183 x 97	2300	•
LDL070	II	20	21	2 x 9w	273 x 97	1500	•
LDL071	II	20	21	3 x 9w	273 x 97	2300	•



LDL052

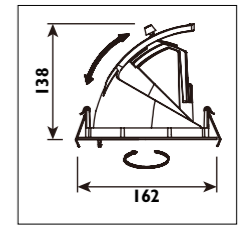

LDL052



LDL053

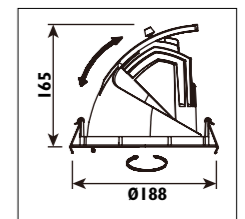





LDL053

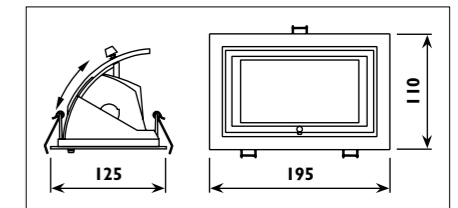

LDL054



LDL054

Die-cast aluminium body								
Code	Class	IP	QC	Lamp/s  LED (Factory fitted) 4000K	Feature/s  Tilt	 Beam angle	Lumen 	Colour/s  White
LDL052	I	20	21	25w	60° (-15°~+45°)	30°	2800	•
LDL053	I	20	21	32w	60° (-15°~+45°)	30°	3600	•
LDL054	I	20	21	32w	60°	30°	3600	•



LDL050

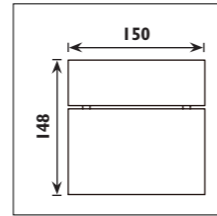

LDL050



LDL051

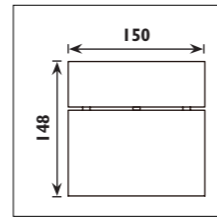

LDL051



LDL058

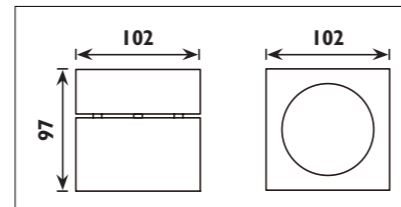

LDL058





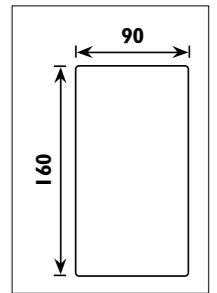



PRT0013-B • PRT0014-B







PRT0013-B • PRT0014-B
PRT0015-W • PRT0016-W



PRT0015-W • PRT0016-W

LDL050 - LDL051 Die-cast aluminium body									
LDL058 Aluminium body									
Code	Class	IP	QC	Lamp/s  LED (Factory fitted) 4000K	Feature/s  Beam angle	Lumen 	Black 	White 	Satin silver 
LDL050	I	20	21	32w		3600		•	•
LDL051	I	20	21	34w		3800		•	•
LDL058	I	20	21	19.5w	40°	1800	•	•	•

Aluminium allow with plastic gear box and PC reflector						
Code	CRI	Lamp/s  LED (Factory fitted) 3000K 4000K	Lumen 	Colour/s Black  White 		
PRT0013-B	>80	10w	600	•		
PRT0014-B	>80	10w	600	•		
PRT0015-W	>80	10w	600		•	
PRT0016-W	>80	10w	600		•	



CA10

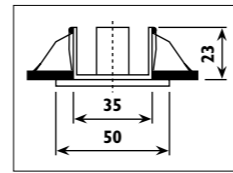

CA10



CB34

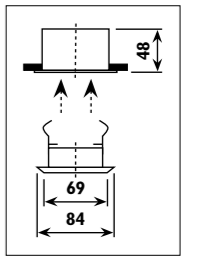

CB34



CA20

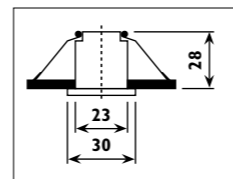

CA20



CB36

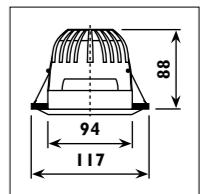

CB36

CA10 Steel body											
CA20 Aluminium body											
Code	Class	IP	QC	Lamp/s		Cutout	Colour/s				Accessories
				12v G4	Transformer required	(mm)	Chrome	Satin chrome	Satin silver	White	Slab box & Slab lid
CA10	III	20	21	10w	•	Ø 40	•	•	•	•	•
CA20	III	20	21	10w	•	Ø 25		•	•	•	•

CB34 Steel and die-cast aluminium body with glass lens											
CB36 Die-cast aluminium body and heat sink, anodised aluminium reflector with glass lens											
Code	Class	IP	QC	Lamp/s		Cutout	Clearance	Colour/s			Accessories
				12v GU5,3	Transformer required	(mm)	Height (mm)	Satin chrome	Chrome	White	Slab box & Slab lid
CB34	III	30	22	50w	•	Ø 75	84	•		•	•
CB36	III	30	32	50w	•	Ø 105	88	•	•	•	•



CB15

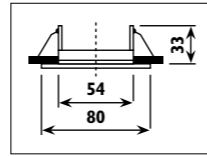

CB15



CD21

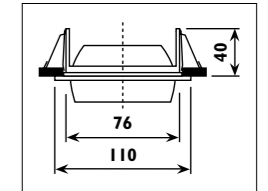

CD21



CB24

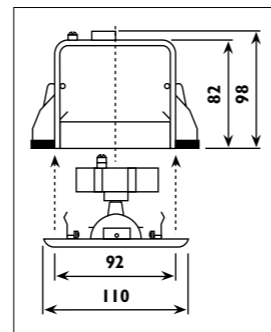

CB24



CC51

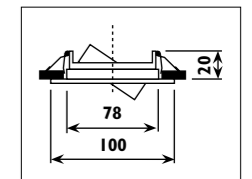

CC51

CB15 Steel body															
CB24 Steel body, die-cast aluminium ring and heat sink															
Code	Class	IP	QC	Lamp/s	Cutout	Clearance	Colour/s						Accessories		
				12v GU5,3 MR16	(mm)	Height (mm)	Black	Chrome	Gold	Gunmetal	Satin chrome	White	Conversion bracket B 56	Slab box & Slab lid L 4-6	
CB15	III	20	21	50w	•	Ø 60	68	•	•	•	•	•	•	HG11	•
CB24	III	20	32	50w	•	Ø 98	98					•			•

Steel body																
Code	Class	IP	QC	Lamp/s	Cutout	Clearance	Features		Colour/s						Accessories	
				12v GU5,3 MR16	(mm)	Height (mm)	Tilt	Rotate	Chrome	Gold	Gunmetal	Satin chrome	Black	White	Slab box & Slab lid L 4-6	Conversion bracket B 56
CD21	III	20	21	50w	•	Ø 80	48	30°	340°	•	•	•	•	•	•	HG11
CC51	III	20	21	50w	•	Ø 85	65	18°		•	•	•	•	•	•	HG11



CB04

Anti-glare

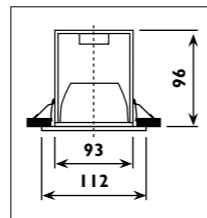

CB04



CB51

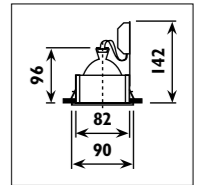

CB51



CB61

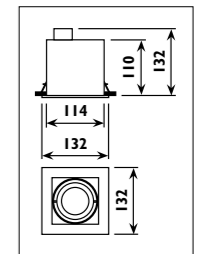

CB61



CB62

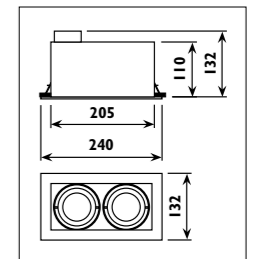

CB62

Steel body with anodised aluminium reflector									
Code	Class	IP	QC	Lamp/s	Cutout	Clearance	Colour/s	Accessories	
				12v GU5,3 MR16	(mm)	Height (mm)	White body/Silver reflector	Transformer required	Slab box & Slab lid L 4-6
CB04	III	20	21	50w	Ø 100	96	.	.	.

CB51 Steel body											
CB61 • CB62 Steel and die-cast aluminium body											
Code	Class	IP	QC	Lamp/s	Cutout	Feature/s		Colour/s		Accessories	Options
				12v GU5,3 MR16	(mm)	Outer tilt	Inner tilt	Satin chrome	Satin silver	Slab box & Slab lid L 4-6	230v versions B 43
CB51	III	20	21	1 x 50w	72 x 82			.	.	.	
CB61	III	20	21	1 x 50w	115 x 115	90°	45°		.		AJ61
CB62	III	20	21	2 x 50w	115 x 220	90°	45°		.		AJ62



CB63

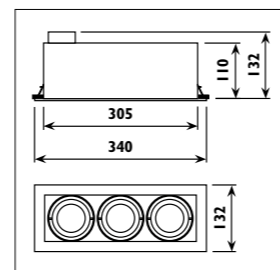

CB63



CB17

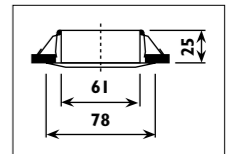

CB17



CC21 • CC24

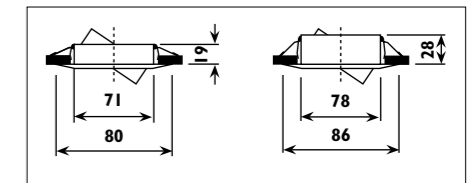

CC21

CC24

Steel and die-cast aluminium body										
Code	Class	IP	QC	Lamp/s	Transformer required	Cutout (mm)	Feature/s		Colour/s	Options
				12v GU5,3 MR16			Outer tilt	Inner tilt	Satin silver	230v versions
CB63	III	20	21	3 x 50w	•	115 x 325	90°	45°	•	AJ63

Die-cast aluminium body																	
Code	Class	IP	QC	Lamp/s	Transformer required	Cutout (mm)	Clearance Height (mm)	Feature/s	Colour/s						Accessories		
				12v GU5,3 MR16				Tilt	Rotate	Chrome	Gold	Gunmetal	Satin brass	Satin chrome	White	Conversion bracket	Slab box & Slab lid
CB17	III	20	22	50w	•	Ø 62	64			•	•	•	•	•	•	HG11	•
CC21	III	20	22	50w	•	Ø 75	62	30°		•	•	•	•	•	•	HG11	•
CC24	III	20	22	50w	•	Ø 75	64	30°	340°						•	HG11	•



CB18

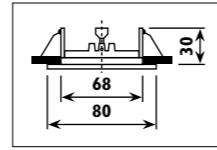

CB18



CC10

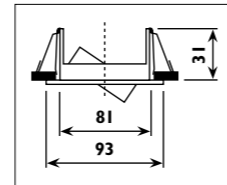

CC10



CC32

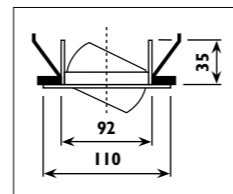

CC32



CC18

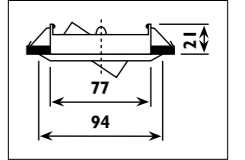

CC18



CC41

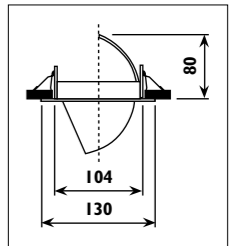

CC41

Die-cast aluminium body with twist off ring														
Code	Class	IP	QC	Lamp/s		Cutout	Clearance	Feature/s	Colour/s				Accessories	
				12v GU5,3 MR16	Transformer required	(mm)	Height (mm)	Tilt	Chrome	Brass	Satin chrome	White	Conversion bracket B 56	Slab box & Slab lid L 4-6
CB18	III	20	22	50w	•	Ø 70	63		•	•	•	•	HG11	•
CC10	III	20	22	50w	•	Ø 83	60	20°	•	•	•	•	HG11	•
CC32	III	20	22	50w	•	Ø 92	66	40°				•	HG11	•

Die-cast aluminium body with twist off ring														
Code	Class	IP	QC	Lamp/s		Cutout	Clearance	Feature/s	Colour/s				Accessories	
				12v GU5,3 MR16	Transformer required	(mm)	Height (mm)	Tilt	Rotate	Brass	Satin chrome	White	Conversion bracket B 56	Slab box & Slab lid L 4-6
CC18	III	20	22	50w	•	Ø 85	63	32°			•	•	HG11	•
CC41	III	20	22	50w	•	Ø 110	80	72°	340°	•	•	•		•



CB44

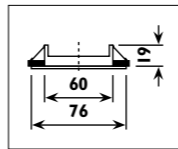

CB44



CB76

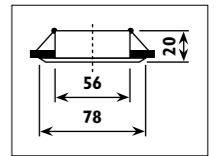

CB76



CC39

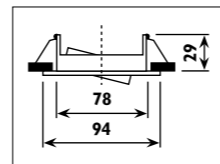

CC39



CB77

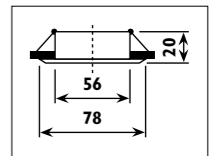

CB77



CC44

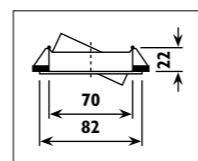

CC44



CC77

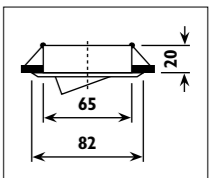

CC77

CC39 Die-cast aluminium body with twist-off ring												
CB44 - CC44 Die-cast aluminium body												
Code	Class	IP	QC	Lamp/s	Cutout	Clearance	Feature/s	Colour/s		Accessories		
				12v GU5,3 MR16 Transformer required	(mm)	Height (mm)	Tilt	Satin chrome	White	Conversion bracket B 56	Slab box & Slab lid L 4-6	
CB44	III	20	22	50w	•	Ø 63	60	•	•	HG11	•	
CC39	III	20	22	50w	•	Ø 82	65	20°	•	HG11	•	
CC44	III	20	22	50w	•	Ø 72	60	35°	•	HG11	•	

CNC aluminium body												
Code	Class	IP	QC	Lamp/s	Cutout	Clearance	Feature/s	Colour/s	Accessories			
				12v GU5,3 MR16 Transformer required	(mm)	Height (mm)	Tilt	Aluminium	Conversion bracket B 56	Slab box & Slab lid L 4-6		
CB76	III	20	32	50w	•	Ø 60	70	•	HG11	•		
CB77	III	20	32	50w	•	Ø 60	70	•	HG11	•		
CC77	III	20	32	50w	•	Ø 67	70	43°	HG11	•		



CB42

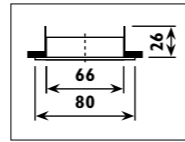

CB42

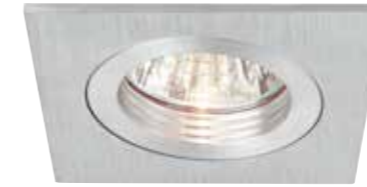

CB43

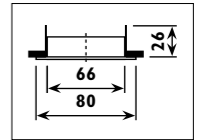

CB43



CC42

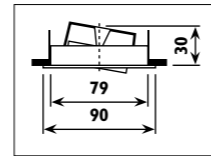

CC42



CC43

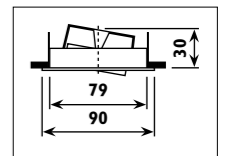

CC43



CC45

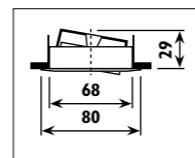

CC45

CNC aluminium body											
Code	Class	IP	QC	Lamp/s		Cutout	Clearance	Feature/s		Colour/s	Accessories
				12v GU5,3 MR16	Transformer required	(mm)	Height (mm)	Tilt	Rotate	Aluminium	Slab box & Slab lid
CB42	III	20	32	50w	•	Ø 70	62			•	•
CC42	III	20	32	50w	•	Ø 82	60	18°	350°	•	•
CC45	III	20	32	50w	•	Ø 72	55	18°		•	•

CNC aluminium body											
Code	Class	IP	QC	Lamp/s		Cutout	Clearance	Feature/s		Colour/s	Accessories
				12v GU5,3 MR16	Transformer required	(mm)	Height (mm)	Tilt	Rotate	Aluminium	Slab box & Slab lid
CB43	III	20	32	50w	•	Ø 70	62			•	•
CC43	III	20	32	50w	•	Ø 82	60	18°	350°	•	•



CB71

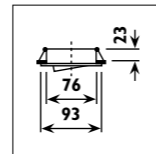

CB71



CB72

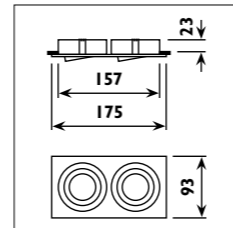

CB72



CB73

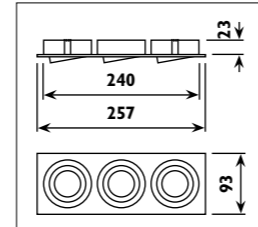

CB73

Related products for CB71 • CB72 • CB73



B 34



CB76 • CB77 • CC77



AJ52

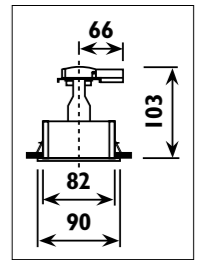

AJ52



CB27

Anti-glare

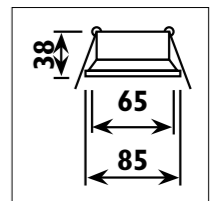

CB27

CNC aluminium body											
Code	Class	IP	QC	Lamp/s	Transformer required	Cutout (mm)	Clearance Height (mm)	Feature/s Tilt	Colour/s Aluminium	Accessories Conversion bracket	Accessories Slab box & Slab lid
CB71	III	20	32	1 x 50w	•	Ø 80	70	43°	•	HG11	•
CB72	III	20	32	2 x 50w	•	80 x 157	70	43°	•	HG11	
CB73	III	20	32	3 x 50w	•	80 x 242	70	43°	•	HG11	

CB27 Die cast aluminium - anti glare adjustable											
AJ52 Steel body											
Code	Class	IP	QC	Lamp/s	Cutout (mm)	Feature/s Inner tilt	Colour/s Satin chrome/Black	Colour/s White	Colour/s Bright white	Colour/s Polished aluminium	Accessories Slab box & Slab lid
AJ52	I	20	21	1 x 50w	80 x 80	30°	•				•
CB27	I	20	22	1 x 50w	Ø76			•	•	•	



ICB15

Empty body only
Lampholder required

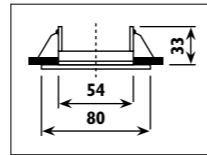

ICB15



ICB17

Empty body only
Lampholder required

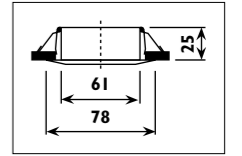

ICB17



ICC51

Empty body only
Lampholder required

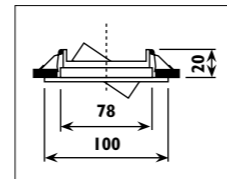

ICC51



ICC21

Empty body only
Lampholder required

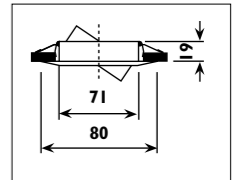

ICC21

Steel body												
Code	Class	IP	QC	Lamp/s		Transformer required (for 12v)	Cutout (mm)	Colour/s		Accessories		
				12v GU5,3 MR16	230v GU10 PAR16			Satin chrome	White	Lampholder	Conversion bracket	Slab box & Slab lid
ICB15	III	20	21	50w	50w	•	Ø 60	•	•	HH900 • HH901	HG11	•
ICC51	III	20	21	50w	50w	•	Ø 85	•	•	HH900 • HH901	HG11	•

Die-cast aluminium body												
Code	Class	IP	QC	Lamp/s		Transformer required (for 12v)	Cutout (mm)	Colour/s		Accessories		
				12v GU5,3 MR16	230v GU10 PAR16			Satin chrome	White	Lampholder	Conversion bracket	Slab box & Slab lid
ICB17	III	20	21	50w	50w	•	Ø 62	•	•	HH900 • HH901	HG11	•
ICC21	III	20	21	50w	50w	•	Ø 75	•	•	HH900 • HH901	HG11	•



ICC10

Empty body only
Lampholder required

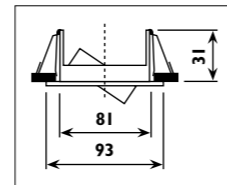

ICC10



ICB18

Empty body only
Lampholder required

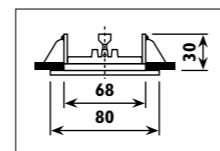

ICB18



BK70

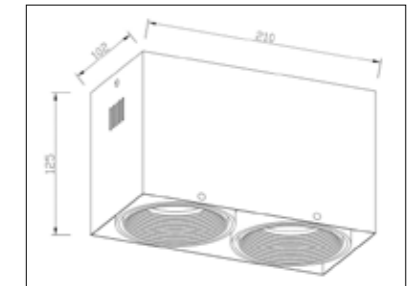

BK70



AM02

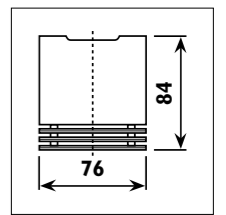

AM02



PRT0024

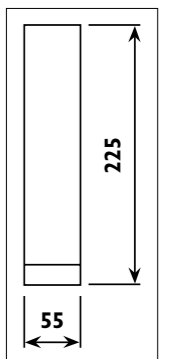

PRT0024

Die-cast aluminium body												
Code	Class	IP	QC	Lamp/s		Transformer required (for 12v)	Cutout (mm)	Colour/s		Accessories		
				12v GU5,3 MR16	230v GU10 PAR16			Satin chrome	White	Lampholder	Conversion bracket	Slab box & Slab lid
ICC10	III	20	22	50w	50w	•	Ø 85	•	•	HH900 • HH901	HG11	•
ICB18	III	20	22	50w	50w	•	Ø 70	•	•	HH900 • HH901	HG11	•

BK70 Steel body									
AM02 Stainless steel body									
PRT0024 Aluminium body with PC lens									
Code	Class	IP	QC	Lamp Base		Feature/s	Colour/s		
				GU10 PAR16	E27		Inner tilt	Matt black	Black
BK70	I	20	21	2 x 50w		30°	•		
AM02	I	20	23	50w					•
PRT0024	I	20	21		60w			•	



AJ61

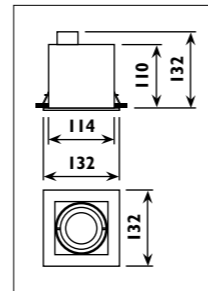

AJ61



AJ62

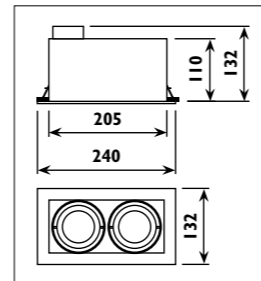





AJ62

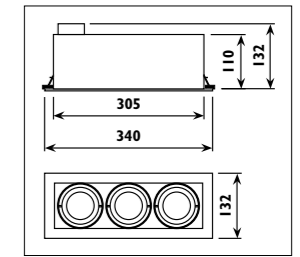





AJ63



AJ63

Steel and die-cast aluminium body									
Code	Class	IP	QC	Lamp/s  230v GU10 PAR16	Cutout  (mm)	Feature/s 		Colour/s  Satin silver	Options 12v versions  B 28-29
						Outer tilt	Inner tilt		
AJ61	I	20	21	1 x 50w	115 x 115	90°	45°	•	CB61
AJ62	I	20	21	2 x 50w	115 x 220	90°	45°	•	CB62
AJ63	I	20	21	3 x 50w	115 x 325	90°	45°	•	CB63

Steel and die-cast aluminium body									
Code	Class	IP	QC	Lamp/s  230v GU10 PAR16	Cutout  (mm)	Feature/s 		Colour/s  Satin silver	Options 12v versions  B 28-29
						Outer tilt	Inner tilt		
AJ61	I	20	21	1 x 50w	115 x 115	90°	45°	•	CB61
AJ62	I	20	21	2 x 50w	115 x 220	90°	45°	•	CB62
AJ63	I	20	21	3 x 50w	115 x 325	90°	45°	•	CB63



AJ10

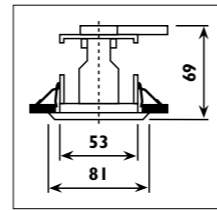

AJ10



AJ20

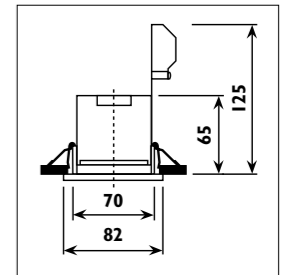

AJ20



AK10

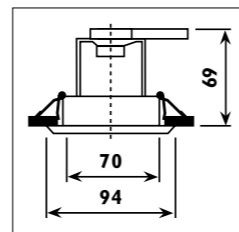







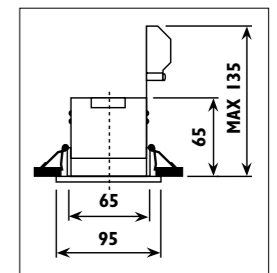

AK10













AK20



AK20

Steel body											
Code	Class	IP	QC	Lamp/s  230v GU10 PAR16	Cutout  (mm)	Feature/s  Tilt	Colour/s				Accessories
											 Slab box & Slab lid 
AJ10	I	20	21	50w	Ø 65	
AK10	I	20	21	50w	Ø 74	18°

Die-cast aluminium body with twist off ring												
Code	Class	IP	QC	Lamp/s  230v GU10 PAR16	Cutout  (mm)	Feature/s  Tilt	Colour/s				Options 12v versions	Accessories
											 CB18	 Slab box & Slab lid 
AJ20	I	20	22	50w	Ø 70		CB18	.
AK20	I	20	22	50w	Ø 85	18°	CC10	.



BK61

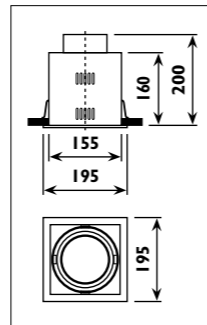

BK61



AA10

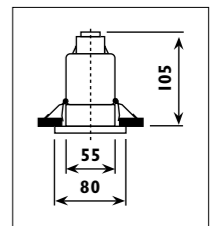

AA10



BK62

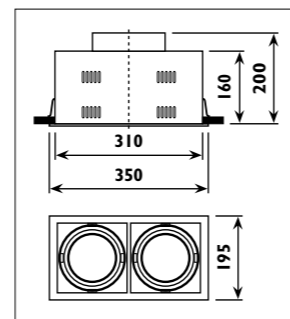

BK62

Steel body												
Code	Class	IP	QC	HID lamp/s		Gear	Cutout	Feature/s			Colour/s	
				230v	G12	Required	(mm)	Outer tilt	Inner tilt	Beam angle*	Satin silver	White
BK61	I	20	31	1 x 35w	1 x 70w	•	170 x 175	17°	30°	24°	•	
BK62	I	20	31	2 x 35w	2 x 70w	•	170 x 315	17°	30°	24°	•	•

* Optional beam angle available on request

Steel body										
Code	Class	IP	QC	Lamp/s			Cutout	Colour/s		
				230v	230v	230v	(mm)	Chrome	Satin chrome	White
				E14	E27	E27				
				R50	R63	R80				
AA10	I	20	21	40w			Ø 65	•	•	•



AA20

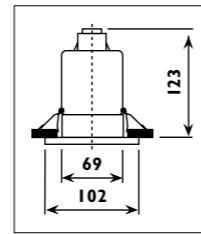

AA20



AF10

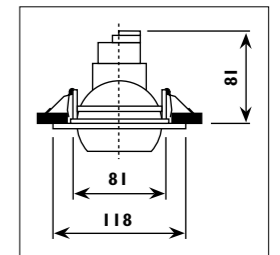

AF10



AA30

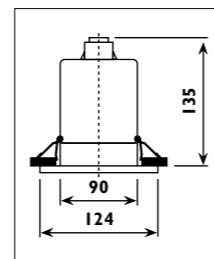

AA30



AF30

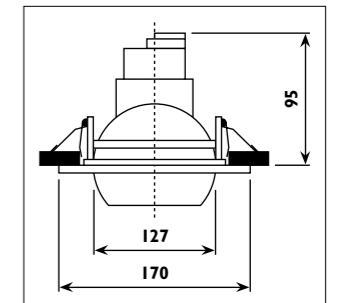

AF30

Steel body										
Code	Class	IP	QC	Lamp/s		Cutout (mm)	Colour/s			
				230v E27 R63	230v E27 R80					
AA20	I	20	21	60w		Ø 80		.	.	.
AA30	I	20	21		100w	Ø 100	.	.		

Steel body										
Code	Class	IP	QC	Lamp/s		Cutout (mm)	Feature/s		Colour/s	
				230v E14 R50	230v E27 R80					
AF10	II	20	21	40w		Ø 100	35°	340°		.
AF30	II	20	21		100w	Ø 140	35°	340°	.	.



AC42

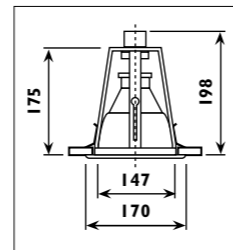

AC42



AC10

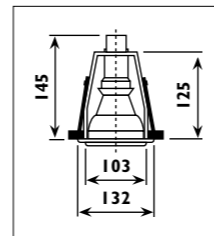

AC10



BA20

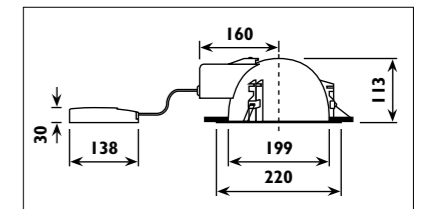

BA20

Steel body with anodised aluminium reflector							
Code	Class	IP	QC	Lamp		Cutout (mm)	Colour/s White body Silver reflector
				Base E27	Type		
AC42	I	20	21	100w	Gen	Ø 157	•
AC10	I	20	21	60w	Gen	Ø 110	•

Steel body with anodised aluminium reflector									
Code	Class	IP	QC	Lamp/s			Ballast Included	Cutout (mm)	Colour/s White body Silver reflector
				230v CFL	2 x 13w	2 x 18w			
BA20	I	20	31	•	•	•	•	Ø 210	•



BG84

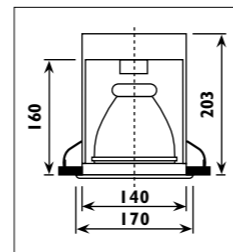

BG84



BG60 • BG62

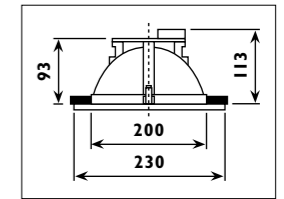

BG60 • BG62



BG86

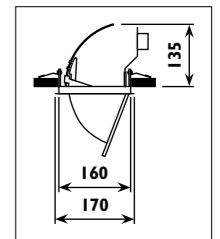

BG86

Steel body, aluminium body, anodised aluminium reflector with glass lens									
Code	Class	IP	QC	HID lamp/s		Cutout	Feature/s	Colour/s	
				230v G12	Gear required	(mm)	Beam angle	White body	Silver reflector
BG84	I	20	31	70w	150w	•	Ø 150	Narrow	•

Die-cast aluminium body, anodised aluminium reflector with glass lens														
Code	Class	IP	QC	Lamp/s		HID lamp/s		Cutout (mm)	Feature/s		Colour/s			
				230v R7s	G12 Metal halide	230v R7s	Gear required		Tilt	Rotate	White body	Silver reflector	Black	Satin silver
BG60	I	20	32	150w		70w	•	Ø 207			•			
BG62	I	20	32			150w	•	Ø 207			•			
BG86	I	21	31	1 x 35w	1 x 70w		•	Ø 164	70°	355°		•	•	•



BG31

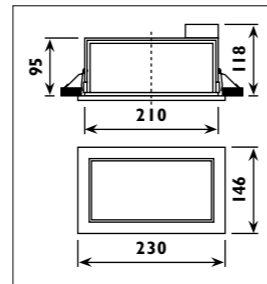

BG31



BG40 • BG42

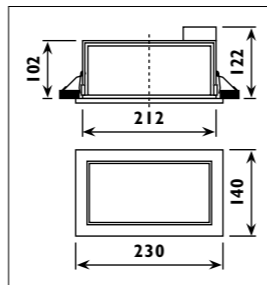

BG40 • BG42



HG11

Conversion bracket

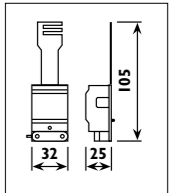

HG11

Die-cast aluminium body, anodised aluminium reflector with glass lens										
Code	Class	IP	QC	Lamp/s 230v R7s QI 118mm	HID lamp/s 230v Rx7s	Gear required	Cutout (mm)	Feature/s Tilt	Colour/s Satin silver body Silver reflector White body Silver reflector	
BG31	I	20	32	200w	70w	•	125 x 210	60°		•
BG40	I	20	32	200w	70w	•	130 x 220	60°	•	
BG42	I	20	32		150w	•	130 x 220	60°	•	

Steel conversion bracket with lampholder and terminal box				
Code	Class	IP	Function	Lamp/s 230v GU10 PAR16
HG11	I	20	Conversion bracket for fixed and adjustable downlights	50w